



HORIZONTAL AIR FLOW OVENS

MODEL: HF15-2, HF25-2, HF37-2

INSTALLATION AND OPERATIONAL MANUAL

P.O. Box 627 ● 300 N. 26th Avenue ● Cornelius, Oregon 97113
EMAIL: [tech @ Shellab.com](mailto:tech@Shellab.com) ● INTERNET: <http://www.Shellab.com>
1-800-322-4897 TELEPHONE (503) 640-3000 FAX (503) 640-1366

TABLE OF CONTENTS

SECTION 1.0	RECEIVING AND INSPECTION
SECTION 2.0	GRAPHIC SYMBOLS
SECTION 3.0	INSTALLATION
SECTION 4.0	CONTROL OVERVIEW
SECTION 5.0	PRECAUTIONS
SECTION 6.0	OPERATION
SECTION 7.0	MAINTENANCE
SECTION 8.0	TROUBLESHOOTING AND SERVICE
SECTION 9.0	PARTS LIST
	UNIT SPECIFICATIONS
	SCHEMATICS

REV. 1/04
4861584

These units are for professional, industrial or educational use where the preparation or testing of materials is done at approximately atmospheric pressure and no flammable, volatile or combustible materials are being heated. These units are not intended for hazardous or household locations or use.

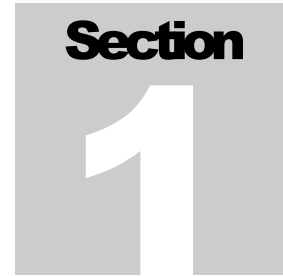







RECEIVING AND INSPECTION

Your satisfaction and safety require a complete understanding of this unit. Read the instructions thoroughly and be sure all operators are given adequate training before attempting to put the unit in service. **NOTE: This equipment must be used only for its intended application; any alterations or modifications will void your warranty.**

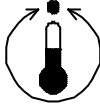
- 1.1 Inspection:** The carrier, when accepting shipment, also accepts responsibility for safe delivery and is liable for loss or damage. On delivery, inspect for visible exterior damage, note and describe on the freight bill any damage found, and enter your claim on the form supplied by the carrier.
- 1.2** Inspect for concealed loss or damage on the unit itself, both interior and exterior. If necessary, the carrier will arrange for official inspection to substantiate your claim.
- 1.3 Return Shipment:** Save the shipping crate until you are sure all is well. If for any reason you must return the unit, first contact your customer representative for authorization. Supply nameplate data, including model number and serial number. Please see the manual cover for information on where to contact customer service.
- 1.4** Verify that all of the equipment indicated on the packing slip is included with the unit. Carefully check all packaging before discarding. The HF15-2 and HF25-2 come equipped with 4 leveling feet, 24 shelf clips and 6 shelves. The HF37-2 comes equipped with 4 leveling feet, 48 shelf clips, and 12 shelves.

GRAPHIC SYMBOLS

Your oven has been provided with a display of graphic symbols which is designed to help in identifying the use and function of the available user, adjustable components.

- 2.1  Indicates that you should consult your manual for further description or discussion of a control or user item.
- 2.2  Indicates “**Adjustable Temperature**”.
- 2.3  Indicates “**AC Power ON**”.
- 2.4  Indicates “**High Limit Safety**”.
- 2.5  Indicates “**Manual Control**”.
- 2.6  Indicates “**Potential Shock Hazard**” behind this protective partition.
- 2.7  Indicates “**Protective Earth Ground**”.

INSTALLATION

Local city, county or other ordinances may govern the use of this equipment. If you have any questions about local requirements, please contact the appropriate local agency.

Installation of the HF12-2, HF25-2, and HF37-2 require hard wiring and should be performed by a qualified electrical technician. The next higher circuit breaker value above the dataplate amperage may be used provided the requirements in article 422 of the National Electric Code are met (USA) or, the National Electric Code that applies in the country where this unit will be operating in.

Under normal circumstances this unit is intended for use indoors, at room temperatures between 5° and 40°C, at no greater than 80% Relative Humidity (at 25°C) and with a supply voltage that does not vary by more than 10%. Customer service should be contacted for operating conditions outside of these limits.

- 3.1 Power Source:** The electrical supply circuit to the oven must conform to all national and local electrical codes. Consult the oven's serial data plate for the voltage, cycle wattage and ampere requirements before making connection. **VOLTAGE SHOULD NOT VARY MORE THAN 10% FROM THE SERIAL PLATE RATING.** This unit is intended for 50/60 Hz application. A separate circuit is recommended to prevent possible loss of product due to overloading or failure of other equipment on the same circuit.
- 3.2 Location:** In selecting a location, consider all conditions which might effect performance, such as heat from radiators, ovens, autoclaves, etc. Avoid direct sun, fast moving air currents, heating/cooling ducts and high-traffic areas. Allow a minimum of 5cm between the unit and walls or partitions which might obstruct free air flow.
- 3.3 Lifting / Handling:** These units are heavy and care should be taken to use appropriate lifting devices that are sufficiently rated for these loads. Units should only be lifted from their bottom surfaces. Doors, handles and knobs are not adequate for lifting or stabilization. The unit should be completely restrained from tipping during lifting or transport. All moving parts, such as shelves and trays should be removed and doors need to be positively locked in the closed position during transfer to prevent shifting and damage.

- 3.4 Leveling:** The unit must sit level and solidly. Leveling feet are supplied and must be installed in the four holes in the bottom corners of the unit. With the feet installed and the unit standing upright, each foot can be raised by turning it in a counterclockwise direction. Adjust the foot at each corner until the unit stands level and solid without rocking. If the unit must be moved, turn the leveling feet all the way clockwise to prevent damage while moving.
- 3.5 Cleaning:** The unit chamber should be cleaned and disinfected prior to use. Remove shelving and shelving supports and clean thoroughly, including all corners using a suitable disinfectant that is appropriate to your application. Regular periodic cleaning is required. Special care should be taken when cleaning around sensing heads to prevent damage. **DO NOT** use chlorine-based bleaches or abrasive cleaners as this will damage the stainless steel interior.
- 3.7** Place shelves in the chamber as desired.

CONTROL PANEL OVERVIEW

- 4.1 Power Switch:** The main power I/O (on/off) switch controls all power to the unit and must be in the I/ON position before any systems are operational.
- 4.2 High Limit Safety Thermostat:** The High Limit Safety is an independent temperature control that must be adjusted by a flat-head screw driver. It prevents temperature runaway in the event that the Main Temperature controller fails. If the chamber temperature rises above the Main Temperature set point, the High Limit maintains temperature at its own set point, preventing sample loss or unit degradation. Please note that it is not recommended that the unit be allowed to operate using only the High Limit to control temperature as temperature uniformity will suffer.
- 4.3 High Limit Activated:** This pilot light is on when the High limit has been activated and has taken control of the heating element. Under normal operating conditions this pilot lamp should never be on.
- 4.4 Main Temperature Controller:** This is a microprocessor based Temperature/Time Control, with ramp and soak capabilities (Watlow model 981).
- 4.5 Power Exhaust Outlet:** The Power Exhaust outlet is controlled by the Main Temperature Controller. It is located at the back of the unit next to the power cord.

Figure 1

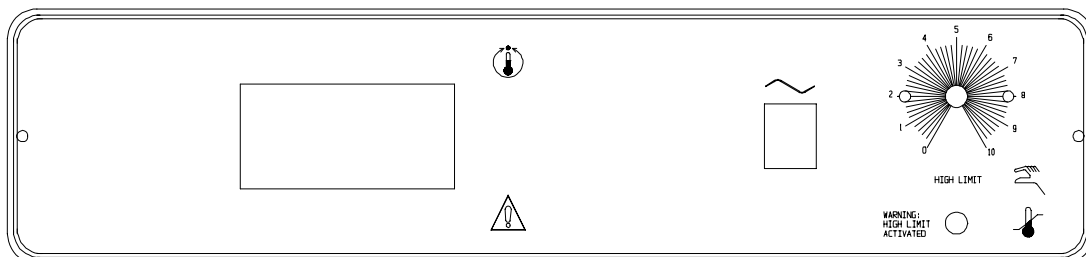

4500659

PRECAUTIONS

- 5.1** This unit has been designed with a dampered vent(s) from the chamber. In order to work effectively and safely, some precautions will need to be taken by the operator.
- a.** In most applications, the exhaust damper will need to be open during drying or degassing for best results.
 - b.** **THIS OVEN IS NOT DESIGNED TO HANDLE COMBUSTIBLE GASSES, AND IS NOT AN EXPLOSION PROOF UNIT. Do not place explosive, combustible, or flammable materials into the chamber.**
 - c.** Some of the out gassed byproducts may be hazardous or unpleasant to operating personnel. If this is the case, the exhaust should be positively ventilated to the outside and dealt with according to local regulations. Your dealer can provide you with a power exhaust which greatly helps under these applications.
- 5.2** Do not operate near noxious fumes.
- 5.3** Do not place sealed or filled containers in the oven chamber.
- 5.4** Do not cut or remove the ground prong from the power cord. Do not use a 2-prong adapter plug.
- 5.5** Be sure that the power supply is of the same voltage as specified.
- 5.6** Disconnect the unit from its electrical source before proceeding to make any electrical repairs or replacements.
- 5.7** If a mercury thermometer is used for verifying chamber temperatures and breakage should occur, all spilled mercury **MUST** be completely removed from the chamber before continuing operation.
- 5.8** This is **NOT** designed for use in Class I, II, or III locations as defined by the National Electric Code.
- 5.9** This oven is not intended, nor can it be used, as a patient connected device.

OPERATION

- 6.1** Check power supply against unit serial plate. They must match.
- 6.2** Models HF15, HF25,2 and HF37-2 must be hard wired by an electrical technician.
- 6.3** Push the power switch to the I/On position, and turn the High Limit Thermostat to its maximum position, clockwise using a flat-head screw driver. The Main Temperature controller should illuminate.
- 6.4** **Setting Main Temperature:** This is explained in full detail in the enclosed Watlow 982 user's manual. The following instructions are for single set point operations only. See Section 7.5 for further simplified instructions. The Watlow 981 controller has 4 automatic settable profiles with six steps within each profile. For programming and set-up instructions turn to Chapter 7, page 7.1 in the Watlow manual.
1. The process (upper window of the controller) will display the current chamber temperature.
 2. The lower window of the controller will indicate the current set point.
 3. To change the set point, press the up or down arrow key until the desired set point is displayed in the lower controller window.
 4. The oven will heat to the selected set point and remain there until changed. Note that the settings will not change if the unit is turned off.
- 6.5** **Simplified 981 Instructions:** The 981 is a microprocessor based ramp and soak, programmable temperature controller. It is capable of being programmed with up to four profiles. A ramp is a controlled change in temperature over a specified period of time. A soak is a hold at particular temperature for a specified period of time with up to six steps each. Profiles can be linked for programs needing more steps up to a total of 21 ramps or soaks.
- A. Single Temperature Operation:** Normally, an average user only wants to operate the oven at one temperature. When the oven is turned on the controller will show the temperature within the oven on the top display. The bottom display will show the set point. The

controller will maintain the temperature within the oven to whatever the lower display is set for. To change the set point press the Up or Down keys until the desired temperature is displayed in the lower display.

- B. Timed Operation:** Sometimes a user will want to operate the oven at a given temperature for a specified period of time and then cool off. To do this, a small program must be put into the controller.

Before attempting to program the controller it is helpful to learn a small amount about how the controller is programmed.

The controller has three main menus. (See the Watlow users manual for in depth information). These are the Setup Menu, Factory Menus, and the Operation Menus.

The Setup Main Menu has four sub menus, Input, Output, Global and Com. These are all preprogrammed at the factory and should need no adjustment under most circumstances. The Factory Menu should never be accessed or changed by anyone other than an authorized factory representative.

The Operation Menu has three sub menus, System, P.I.D. and Program. The System and P.I.D. Menus are factory preset and should not need any adjustment under normal circumstances. The third sub menu under Operation Menu is programmed and this is where you program your Ramp and Soak Files.

The Program Sub Menu is used to input time and temperature steps into the controller. The five types of steps that can be programmed are Set Point, Soak, Jump Loop, Link File and End. A Set Point step inputs the temperature desired and the time taken to get to that temperature. A Soak step only inputs the amount of time that the temperature in the previous step is maintained. A Jump Loop tells the controller to jump to another step. A Link File jumps to another profile and End step ends the program.

In programming, each step is a series of commands. For a Set Point step commands are SP (Set Point), Hours (Hours), Min (Minutes), Sec (Seconds), ENT3 (Event Three the power exhaust outlet). The set point is the temperature that you want the oven to go to. The Hours, Minutes, Seconds is the time you want the oven to take to reach set point. If you want the oven to reach set point as fast as possible then set these times to zero. The Event Three is whether the power exhaust outlet is turned on or off.

A Jump Loop step has only three commands, JF (Jump File), JS (Jump Start), and JC (Jump Count).

The Link File step has only one command LFIL File to link to an End step has only one command END.

An example of a simple program would be one in which you want the oven at 90 to 100 degrees, maintain 100 degrees for 5 ½ hours and then cool down to room temperature. This would be a four step program. The first step would be Set Point step. The Set Point would be 100 degrees. The time would be programmed as zero since you want the oven to get 100 as fast as possible. The second step would be a Soak Step. The soak time would be 5 hours and 30 minutes. The third step would be a Set Point step with the set point set to zero and the time set to zero. The final step would be an End step.

- 6.6 Setting High Limit:** Prior to setting the High Limit Control be certain the Main temperature Control has reached the input set point and has remained stable for several hours. This will insure that the High Limit is set at the proper temperature. As stated in 4.3, the High Limit control should be at maximum position, clockwise. Now turn the thermostat counter-clockwise using a flat-head screwdriver until the High Limit Activated indicator light comes on. Next turn the thermostat clockwise just until the indicator light turns off. Then turn the thermostat clockwise two (2) minor increments on its scale past the point where the indicator light went out. This will set the High Limit at approximately 10°C above the Main Temperature set point.

MAINTENANCE

- 7.1 Cleaning:** The unit chamber should be cleaned and disinfected on a regular basis. Remove shelving & shelving supports then clean thoroughly, including all corners using a suitable disinfectant that is appropriate to your application. Regular periodic cleaning is required. Special care should be taken when cleaning around sensing heads to prevent damage. **DO NOT** use chlorine based bleaches or abrasive cleaners as this will damage the stainless steel interior. **DO NOT** use spray cleaners that might leak through openings and cracks and get on electrical parts or that may contain solvents that will harm the coatings.

Warning: Never clean the unit with alcohol or flammable cleaners with the unit connected to the electrical supply. Always disconnect the unit from the electrical service when cleaning and assure all volatile or flammable cleaners are evaporated and dry before reattaching the unit to the power supply.

- 7.2 Storage:** If the oven is to be turned off it can be reactivated without controller adjustments. Prior to storage the interior should be wiped dry to eliminate contamination. If the unit is to be transported disconnect the power supply, remove shelving and screw the leveling feet in. See Section 3.3 Lifting/handling for transport instructions.
- 7.3** There is **No** Maintenance required on the electrical components. If the unit fails to operate as specified please review the troubleshooting guide prior to calling for technical support.

TROUBLESHOOTING

TEMPERATURE

Temperature too high

- 1/ controller set too high-see your Watlow users manual
- 2/ controller failed on – call Customer Service
- 3/ wiring error – call Customer Service

Display reads "HI" or "400"+

Probe is unplugged, is broken or wire to sensor is broken – trace wire from display to probe; move wire and watch display to see intermittent problems

Chamber temp spikes over set point and then settles to set point

Recalibrate – see Watlow users manual

Temperature too low

- 1/ high limit set too low – see section 4.5
- 2/ controller set too low – see Watlow users manual
- 3/ unit not recovered from door opening – wait for display to stop changing
- 4/ unit not recovered from power failure or being turned off – incubators will need 24 hours to warm up and stabilize
- 5/ element failure – call Customer Service
- 6/ controller failure – confirm with front panel lights that controller is calling for heat
- 7/ high limit failure – confirm with front panel lights that High Limit is operating correctly
- 8/ wiring problem – check all functions and compare wiring to owners manual - especially around any areas recently worked on
- 9/ loose connection – check shadow box for loose connections

Display reads "LO"

- 1/ sensor is plugged in backwards – call Customer Service
- 2/ if ambient room temperature is lower than range of unit – compare set points and ambient temperature to rated specifications in Section 10.0

Unit will not heat over a temperature that is below set point

- 1/ confirm that blower motor is moving and that amperage and voltage match data plate – check blower motor motion in shadow box and feel for air movement in chamber
- 2/ confirm that set point is set high enough –turn High Limit clockwise and see if High Limit light comes on
- 3/ check connections to sensor
- 4/ check calibration – using independent reference thermometer, follow instructions in Watlow users manual

Unit will heat up at all

- 1/ verify that controller is asking for heat by looking for controller light – if controller light is not on, there is a problem with the controller
- 2/check amperage – amperage should be virtually at maximum rated (data plate) amperage
- 3/ do all controller functions work?
- 4/ is the High Limit set high enough? – for diagnostics, should be fully clockwise with the pilot light never on
- 5/ HAS THE FUSE/CIRCUIT BREAKER BLOWN?

Indicated chamber temperature unstable

- 1/ ± 0.1 may be normal
- 2/ is blower motor working? – remove top panel and verify movement of blower motor in shadow box
- 3/ is ambient room temperature radically changing – either door opening or room airflow from heaters or air conditioning? – stabilize ambient conditions
- 4/ it may happen if exhaust stack is 100% open or if power exhaust is cycling – adjust stack to at least $\frac{1}{4}$ closed
- 5/ sensor miss-located, damaged or wires may be damaged - check mounts for control and High Limit sensors, then trace wires between sensors and controls
- 6/ calibration sensitivity – call Customer Service
- 7/ high limit set too low – be sure that High Limit is more than 5 degrees over desired set point; check if High Limit pilot is on continuously; turn controller knob completely clockwise to see if problem solved then follow instructions in Section 7.5 for correct setting
- 8/ electrical noise – remove nearby sources of RFI including motors, arcing relays or radio transmitters
- 9/ bad connection on temperature sensor or faulty sensor – check connectors for continuity and mechanical soundness while watching display for erratic behavior; check sensor and wiring for mechanical damage
- 10/ bad connections or faulty solid state relay – check connectors for mechanical soundness and look for corrosion around terminals or signs of arcing or other visible deterioration

Will not maintain set point

- 1/ assure that set point is at least 5 degrees over ambient room temperature
- 2/ see if ambient is fluctuating

Display and actual reference thermometer don't match

- 1/ calibration error – see Watlow users manual
 - 2/ temperature sensor failure – call Customer Service
 - 3/ controller failure – call Customer Service
 - 4/ allow at least two hours to stabilize
 - 5/ verify that reference thermometer is certified
- See above

Can't adjust set points or calibration

- 1/ turn entire unit off and on to reset
- 2/ if repeatedly happens, call Customer Service

Calibrated at one temperature, but not at another

This can be a normal condition when operating temperature

varies widely. For maximum accuracy, calibration should be done at or as close to the set point temperature.

MECHANICAL

Door not sealing

- 1/ check physical condition of gasket
- 2/ assure that gasket is in original location

Motor doesn't move

- 1/ if shaft spins freely: check connections to motor and check voltage to motor
- 2/ if shaft rubs or is frozen, relieve binding and retest

Motor makes noise

- 1/ If noise is from the motor, tap the top of motor shaft with ball peen hammer.
- 2/ If the sound gets worse, tap the other end of the shaft – avoiding touching the blower wheel.
- 3/ If there is no change, call Customer Service.

OTHER

Controller on at all times - "locked-up"

- 1/ Adjust set point to room temperature. If the light goes out but is still heating, replace the solid state relay.
- 2/ turn unit off and on to reset
- 3/ if cannot change any condition on the front panel, call Customer Service

Controller timer resets on its own

- 1/ confirm that power from wall is consistent and within specs
- 2/ call Customer Service with serial number

Front panel displays are off

- 1/ Check for wire damage.

Unit or wall fuse/circuit breaker is blown

- 1/ check wall power source
- 2/ compare current draw and compare to specs on data plate
- 3/ see what other loads are on the wall circuit

Unit will not turn on

- 1/ check wall power source
- 2/ check fuse/circuit breaker on unit or in wall
- 3/ see if unit is on, e.g., fan or heater, and just controller is off
- 4/ check all wiring connections, esp. around the on/off switch

Unit is smoking –out of box

- 1/ Put unit under vent and run at full power for one hour.
- 2/ Models 1601 and 1605 follow special burn in procedures in section 6.0

Contamination in chamber

- 1/ see cleaning procedure in operator's manual
- 2/ develop and follow SOP for specific application; include definition of cleaning technique and maintenance schedule

Contamination in sample

- 1/ see "Contamination in chamber"
- 2/ reduce air flow in chamber by dampening down inlet restrictor; be sure to verify adequate temperature uniformity at the reduced air flow
- 3/ protect open samples from areas of maximum air current, e.g., inlet air ducts

SERVICE

If this product should require service, contact your service representative. For information on where to reach customer service please see the front cover of this manual. Should return of this product be necessary a return Authorization number must be obtained and the product shipped according to your representatives instructions to the indicated service center, if a return authorization number is not obtained for the product it will be returned back to the sender. To insure prompt handling, the return authorization number should be placed on the outside of the package and a detailed explanation of the return enclosed with the item. After receiving the Return Authorization number, the item must be received within 30 days if not the return authorization will be void.

PARTS LIST

Description	Part No.
Blower Motor	4880512
Control Relay	102162
Convenience Outlet	101483
Cooling Fan	210001
Heating Element – HF15-2, HF25-2, HF37-2	101592
High Limit Controller – 1675, 1680, 1685, 1690	1750571
High Limit Indicator Pilot Lamp	200020
Leveling Feet	200129
ON/OFF Switch	X1000124
Power Relay – HF15-2	100064
Power Relay – HF25-2, HF37-2	200096
Shelf – HF15-2	5120871
Shelf – HF25-2	5120564
Shelf – HF37-2	5120941
Shelf Clip	200137
Temperature Probe –HF15-2, HF25-2, HF37-2	200073
Watlow 981 Main Temperature Controller	1750540
CE Complied Models (European Standards)	
Filter – HF15-2 - 1 each	2800504
Filter – HF25-2, HF37-2 - 2 each	2800504

UNIT SPECIFICATIONS

Weight	Shipping	Net
HF15-2	630 lbs.	445 lbs.
HF25-2	820 lbs.	
HF37-2	980 lbs.	

Dimensions	Exterior WxDxH (in)	Interior WxDxH (in)
HF15-2	59 x 29 x 57	44 x 20.5 x 36
HF25-2	42.5 x 32 x 83	32 x 26.5 x 67
HF37-2	68 x 33 x 80	44 x 25 x 54

Capacity	Cubic Feet
HF15-2	14.6 – dbl door
HF25-2	25
HF37-2	37.9 – dbl door

Temperature	Range	Uniformity	Control
HF15-2	40 to 260°C	$\pm 1.0^\circ @ 100^\circ\text{C}$	0.1°C
HF25-2	40 to 260°C	$\pm 1.0^\circ @ 100^\circ\text{C}$	0.1°C
HF37-2	40 to 260°C	$\pm 1.0^\circ @ 100^\circ\text{C}$	0.1°C

Recovery Time	150°C (door open 30 sec)	200°C (door open 30 sec)
HF15-2	5 min	25 min
HF25-2	5 min	25 min
HF37-2	7 min	25 min

WIRE DIAGRAM

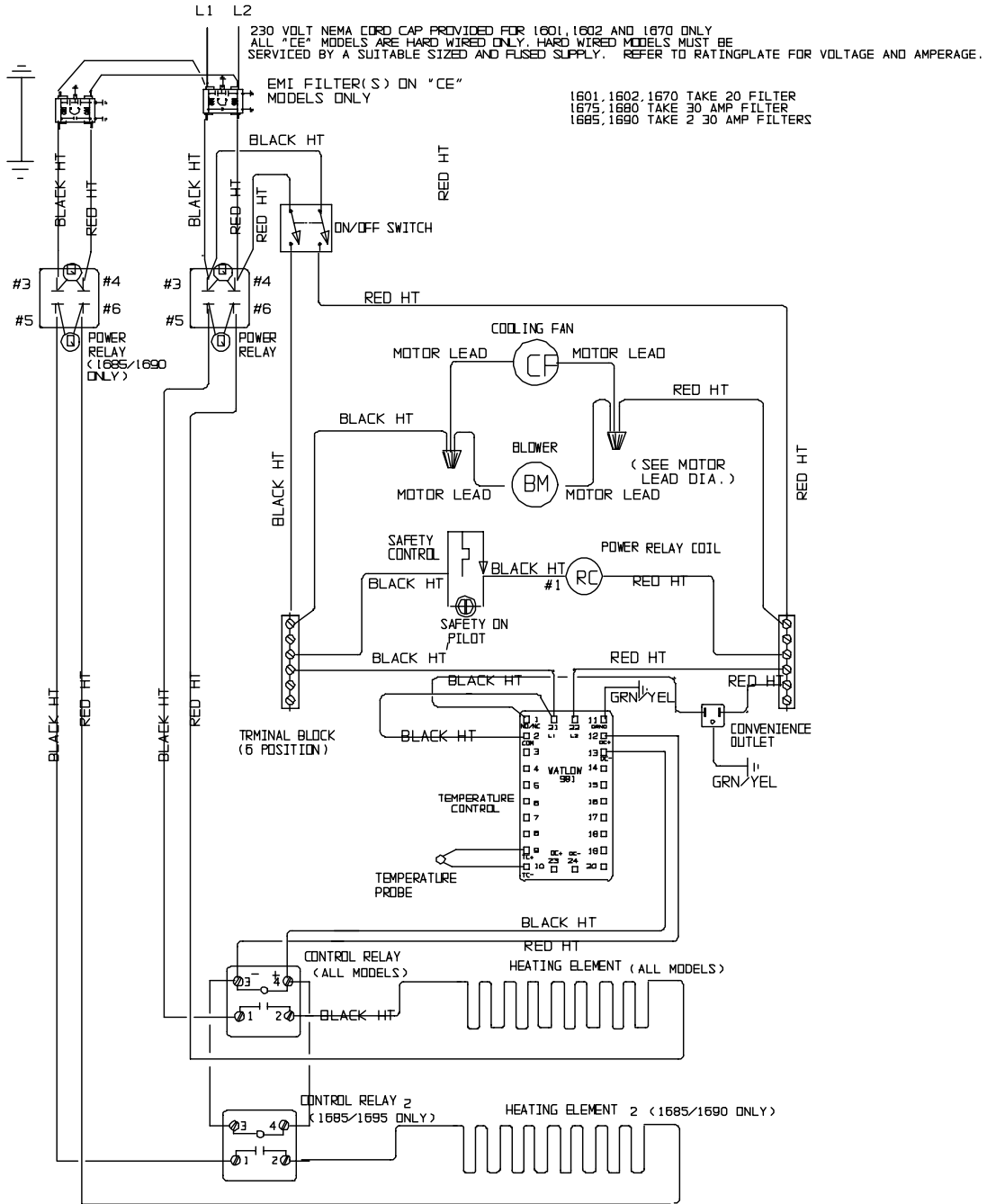

9850731